

Dell PowerEdge M1000e, M915, M910, M820, M710HD, M710, M620, M610x, M610, M520, and M420 Getting Started Guide

Regulatory Model: BMX01, DWHH, HHB, FHB, and QHB
Regulatory Type: DWHH Series, HHB Series, FHB Series, and QHB
Series



Notes, Cautions, and Warnings



NOTE: A NOTE indicates important information that helps you make better use of your computer.



CAUTION: A CAUTION indicates either potential damage to hardware or loss of data and tells you how to avoid the problem.



WARNING: A WARNING indicates a potential for property damage, personal injury, or death.

© 2013 Dell Inc. All Rights Reserved.

Trademarks used in this text: Dell™, the Dell logo, Dell Boomi™, Dell Precision™, OptiPlex™, Latitude™, PowerEdge™, PowerVault™, PowerConnect™, OpenManage™, EqualLogic™, Compellent™, KACE™, FlexAddress™, Force10™, Venue™ and Vostro™ are trademarks of Dell Inc. Intel®, Pentium®, Xeon®, Core® and Celeron® are registered trademarks of Intel Corporation in the U.S. and other countries. AMD® is a registered trademark and AMD Opteron™, AMD Phenom™ and AMD Sempron™ are trademarks of Advanced Micro Devices, Inc. Microsoft®, Windows®, Windows Server®, Internet Explorer®, MS-DOS®, Windows Vista® and Active Directory® are either trademarks or registered trademarks of Microsoft Corporation in the United States and/or other countries. Red Hat® and Red Hat® Enterprise Linux® are registered trademarks of Red Hat, Inc. in the United States and/or other countries. Novell® and SUSE® are registered trademarks of Novell Inc. in the United States and other countries. Oracle® is a registered trademark of Oracle Corporation and/or its affiliates. Citrix®, Xen®, XenServer® and XenMotion® are either registered trademarks or trademarks of Citrix Systems, Inc. in the United States and/or other countries. VMware®, vMotion®, vCenter®, vCenter SRM™ and vSphere® are registered trademarks or trademarks of VMware, Inc. in the United States or other countries. IBM® is a registered trademark of International Business Machines Corporation.

2013 - 09

Rev. A00

Installation And Configuration

 **WARNING:** Before performing the following procedure, review the safety instructions that came with the blade server or enclosure.

 **NOTE:** The system is intended for restricted access location in accordance with the National Electric Code, National Standards Institute (ANSI/National Fire Protection Association (NFPA) 70.

Unpacking The System

Unpack your blade server or enclosure and identify each item.

Installing The Enclosure In The Rack

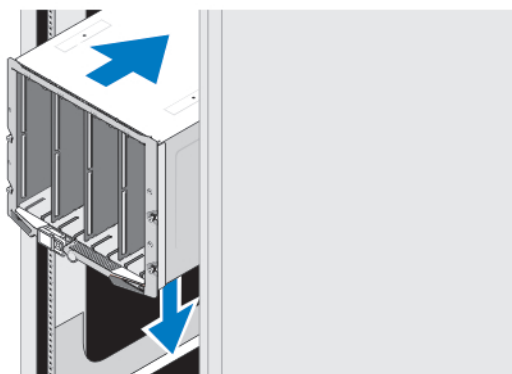



Figure 1. Installing the Enclosure in the Rack

Assemble the rails and install the enclosure in the rack, following the safety instructions and the rail installation instructions that shipped with the rail kit.

Installing A Sleeve In The Enclosure

 **NOTE:** This procedure applies only to PowerEdge M420.

A sleeve includes up to four quarter-height blades to function as a system. Depending on your order, the sleeve may ship with the blades preinstalled.

 **CAUTION:** Exercise utmost care when installing or removing the sleeve to prevent damage to the internal components. To ensure protection for the electronic components inside, follow the Electrostatic Discharge (ESD) guidelines.

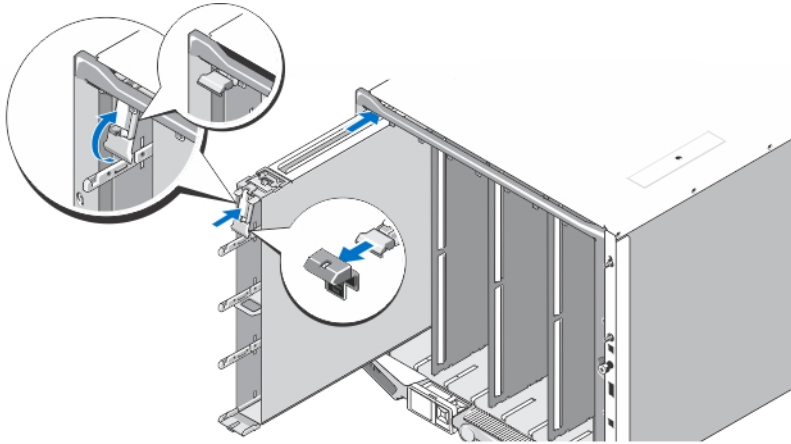



Figure 2. Installing a Sleeve

-  **NOTE:** Before you install or remove a sleeve from the enclosure, ensure that the top slot of the sleeve (Blade a) is empty. You can install a blade in the top slot (Blade a) after you install the sleeve in the enclosure.

Remove the orange cover from the sleeve handle. Slide the sleeve into the enclosure and lift the sleeve handle to the top position to secure the sleeve in the enclosure.

-  **NOTE:** To ensure optimal thermal performance, do not replace the cover on the sleeve handle after the sleeve is installed in the enclosure. Reinstall the cover only if the sleeve is not installed in the enclosure.

Installing A Quarter-Height Blade In A Sleeve

-  **CAUTION:** Install a blade blank in all empty blade slots to maintain proper thermal conditions.

Slide the blade into the sleeve and rotate the blade handle upward to secure the blade in the sleeve.

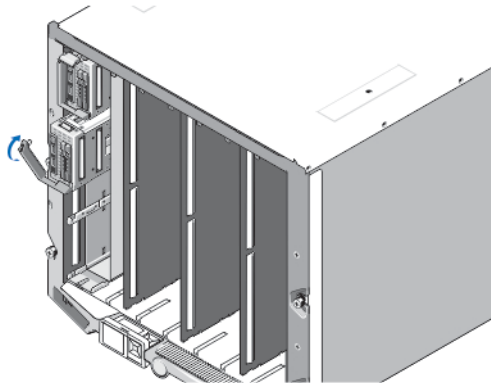

Figure 3. Installing a Quarter-Height Blade

Installing A Full Or Half-Height Blade

-  **CAUTION:** Install a blade blank in all empty blade slots to maintain proper thermal conditions.

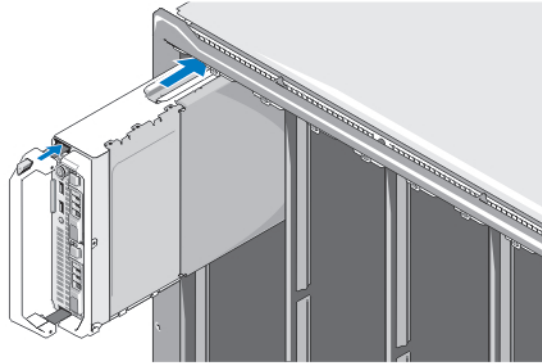

Figure 4. Installing a Half-Height Blade

NOTE: The above figure shows installation of a half-height blade. The procedure for installing a full-height blade is identical to installing a half-height blade.

Beginning at the top, slide the blades into the enclosure from left to right. When the blade is securely installed, the blade handle returns to the closed position.

Connecting The CMC And iKVM Modules

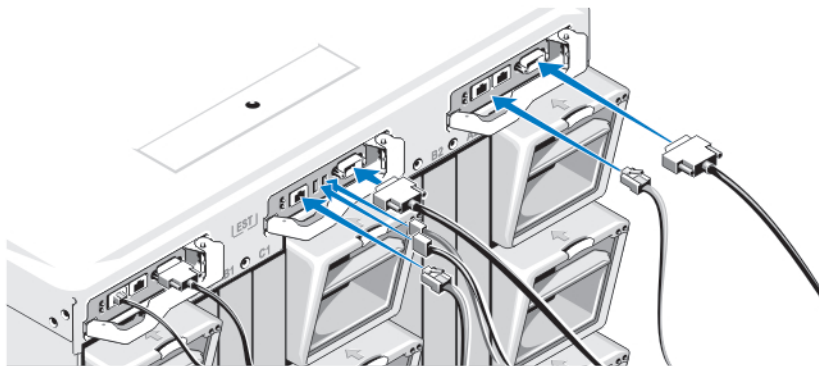

Figure 5. Connecting the CMC and iKVM Modules

Connect the serial cable and network cable(s) from the management system to the CMC module. If a second optional CMC module is installed, connect it as well.

Connect the keyboard, mouse, and monitor to the optional iKVM module.

Connecting The System To Power

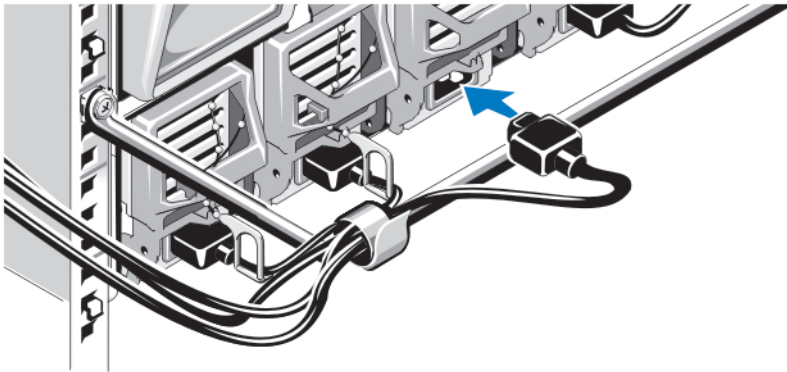

Figure 6. Connecting Power to the System

Connect the system power cables to the system power supplies.

- ⚠ **CAUTION:** Many repairs may only be done by a certified service technician. You should only perform troubleshooting and simple repairs as authorized in your product documentation, or as directed by the online or telephone service and support team. Damage due to servicing that is not authorized by Dell is not covered by your warranty. Read and follow the safety instructions that came with the product.
- ⚠ **CAUTION:** To prevent the power cables from being disconnected accidentally, use the plastic clip on each power supply to secure the power cable to the power supply, and use the strap to secure the power cable to the strain-relief bar.
- ⚠ **CAUTION:** For AC power supply, do not plug the power cables directly into a power outlet; you must use a PDU. For optimal system functionality, a minimum of three power supplies are required.

Plug the other end of the power cables of the AC power supplies into a power distribution unit (PDU). The system requires a minimum of two PDUs and up to six PDUs depending on the PDU rating. Each PDU must be powered to a separate appropriate rated branch circuit-protective ground AC power source. For DC power supplies, plug the other end of the power cables to a branch circuit-protective ground DC power source.

- 🔧 **NOTE:** All power supplies in the enclosure must be of the same type and have the same maximum output power.
- 🔧 **NOTE:** AC and DC power supplies cannot be mixed in an enclosure.

Turning On The Enclosure

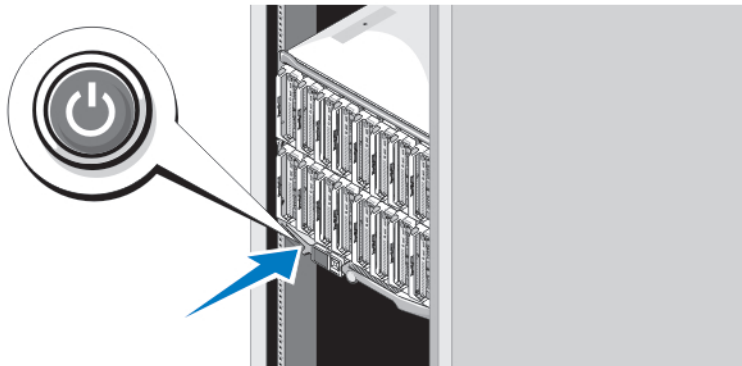

Figure 7. Turning on the Enclosure

Press the power button on the enclosure. The power indicator should light.

Turning On The Blades

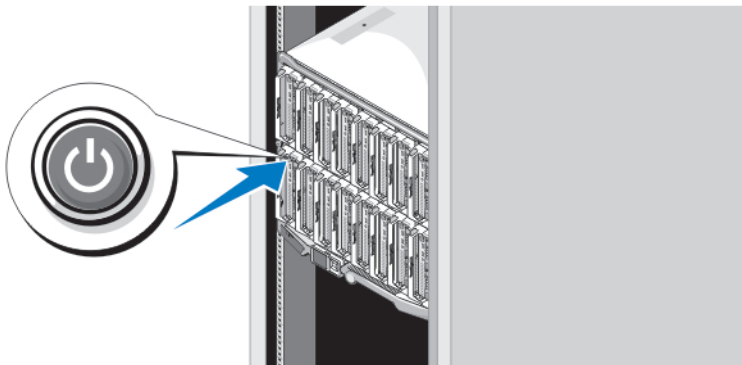



Figure 8. Turning on a Blade

Press the power button on each blade, or power on the blades using the systems management software.

Complete The Operating System Setup

If you purchased a preinstalled operating system, see the documentation associated with the operating system. To install an operating system for the first time, see the installation and configuration documentation for your operating system. Be sure the operating system is installed before installing hardware or software not purchased with the system.

 **NOTE:** See dell.com/ossupport for the latest information on supported operating systems.

Dell Software License Agreement

Before using your system, read the Dell Software License Agreement that came with your system. You must consider any media of Dell-installed software as BACKUP copies of the software installed on your system's hard drive. If you do not accept the terms of the agreement, call the customer assistance telephone number. For customers in the United States, call 800-WWW-DELL (800-999-3355). For customers outside the United States, see dell.com/support and select your country or region from the top left of the page.

Related Information

 **WARNING:** See the safety and regulatory information that shipped with your system. Warranty information may be included within this document or as a separate document.

- The Owner's Manual provides information about system features and describes how to troubleshoot the system and install or replace system components. This document is available online at dell.com/poweredgemanuals.
- The blade Owner's Manuals provide information about the blade features and describe how to troubleshoot the systems and install or replace system components. These documents are available online at dell.com/poweredgemanuals.
- For the Owner's Manuals and Installation Guides for Dell EqualLogic hardware, go to support.equallogic.com.
- The CMC User's Guide provides information on installing, configuring, and using the CMC. This document is available online at dell.com/esmmanuals.
- The Integrated Dell Remote Access Controller (iDRAC) User's Guide provides information about installation, configuration and maintenance of iDRAC on managed systems. This document is available online at dell.com/esmmanuals.
- The rack documentation included with your rack solution describes how to install your system into a rack, if required.
- Any media that ships with your system that provides documentation and tools for configuring and managing your system, including those pertaining to the operating system, system management software, system updates, and system components that you purchased with your system.

 **NOTE:** Always check for updates on dell.com/support/manuals and read the updates first because they often supersede information in other documents.

 **NOTE:** When upgrading your system, it is recommended that you download and install the latest BIOS, drivers, and systems management firmware on your system from dell.com/support.

Obtaining Technical Assistance

If you do not understand a procedure in this guide or if the system does not perform as expected, see your system Owner's Manual. Dell offers comprehensive hardware training and certification. See dell.com/training for more information. This service may not be offered in all locations.

NOM Information

The following information is provided on the device described in this document in compliance with the requirements of the official Mexican standards (NOM):

Importer: Dell Inc. de México, S.A. de C.V.
Paseo de la Reforma 2620 -11º Piso

Col. Lomas Altas
11950 México, D.F.

Model number: BMX01
Supply voltage: 100 V CA to 240 V CA (with 2700 W AC power supply units) or –(48–60) V CC (with 2700 W DC power supply units)
200 V CA to 240 V CA (with 3000 W AC power supply units)
Frequency: 50 Hz/60 Hz or N/A
Current consumption: 16 A (x6) or 75 A (x6)

Model number: FHB
Supply voltage: 12 V CC
Current consumption: 75 A

Model number: HHB
Supply voltage: 12 V CC
Current consumption: 37 A

Model number: QHB
Supply voltage: 12 V CC
Current consumption: 35 A

Technical Specifications

 **NOTE:** For additional specifications, see your system *Owner's Manual*.

Power — Blades

Coin-cell battery	3 V CR2032 Lithium coin cell
-------------------	------------------------------

Power — Enclosure

AC/DC power supply (per power supply module) (2700 W)

Wattage	2700 W
Connector	IEC C20
Heat dissipation	1205 BTU/hr (maximum)
Maximum inrush current	Under typical line conditions and over the entire system ambient operating range, the inrush current may reach 55 A per power supply for 10 ms or less.

AC/DC power supply (per power supply module) (3000 W)

Wattage	3000 W
Connector	IEC 320

Power — Enclosure

Heat dissipation 1200 BTU/hr (maximum)

 **NOTE:** Heat dissipation is calculated using the power supply wattage rating.

Maximum inrush current Under typical input voltage conditions and over the entire system ambient operating range, the inrush current may reach 55 A per power supply for 10 ms or less.

System Voltage Requirements 16 A, 200 V AC to 240 V AC, 50 Hz/60 Hz (3000 W power supply)

 **NOTE:** This system is also designed to be connected to IT power systems with a phase to phase voltage not exceeding 230 V. 16 A, 100 V AC to 240 V AC, 50 Hz/60 Hz (2700 W power supply)

DC/DC power supply (per power supply module)

Wattage 2700 W

Connector Molex # 394260002 at PSU end, mating connector Molex # 39422-0012

Heat dissipation 1205 BTU/hr (maximum)

Maximum inrush current Under typical input voltage conditions and over the entire system ambient operating range, the inrush current may reach 120 A per power supply for 10 ms or less.

System Voltage Requirements 75 A, 48 V DC to 60 V DC

 **NOTE:** Heat dissipation is calculated using the power supply wattage rating.

Physical — Blades

PowerEdge M915

Height 38.5 cm (15.2 inch)

Width 5 cm (2 inch)

Depth 48.6 cm (19.2 inch)

Weight (maximum) 12.7 kg (28 lb)

PowerEdge M910

Height 38.5 cm (15.2 inch)

Width 5 cm (2 inch)

Depth 48.6 cm (19.2 inch)

Weight (maximum) 13.1 kg (29 lb)

PowerEdge M820

Height 38.5 cm (15.2 inch)

Width 5 cm (2 inch)

Physical — Blades

Depth	48.6 cm (19.2 inch)
Weight (maximum)	14.5 kg (31.9 lb)
PowerEdge M710 and M610x	
Height	38.5 cm (15.2 inch)
Width	5 cm (2 inch)
Depth	48.6 cm (19.2 inch)
Weight (maximum)	11.1 kg (24.5 lb)
PowerEdge M710HD and M620	
Height	18.9 cm (7.4 inch)
Width	5 cm (2 inch)
Depth	48.6 cm (19.2 inch)
Weight (maximum)	7.4 kg (16.3 lb)
PowerEdge M610	
Height	18.9 cm (7.4 inch)
Width	5 cm (2 inch)
Depth	48.6 cm (19.2 inch)
Weight (maximum)	5.2 kg to 6.4 kg (11.5 lb to 14.0 lb)
PowerEdge M520	
Height	18.9 cm (7.4 inch)
Width	5 cm (2 inch)
Depth	48.6 cm (19.2 inch)
Weight (maximum)	6.4 kg (14.1 lb)
PowerEdge M420	
Sleeve	
Height	39.5 cm (15.6 inch)
Width	5 cm (2 inch)
Depth	44.3 cm (17.4 inch)
Weight	3 kg (6.61 lb)
Blade	
Height	9.75 cm (3.8 inch)
Width	5 cm (2 inch)
Depth	45.8 cm (18 inch)
Weight (maximum)	2.3 kg (5.07 lb)

Physical — Enclosure

Height	44.0 cm (17.3 inch)
Width	44.7 cm (17.6 inch)
Depth	75.5 cm (29.7 inch)
Weight (maximum)	200.5 kg (442 lb)
Weight (empty)	44.6 kg (98.1 lb)

Environmental



NOTE: For additional information about environmental measurements for specific system configurations, see dell.com/environmental_datasheets.

Temperature

Maximum Temperature Gradient (Operating and Storage)	20 °C/h (36 °F/h)
Storage Temperature Limits	–40 °C to 65 °C (–40 °F to 149 °F)

Temperature (Continuous Operation)

Temperature Ranges (for altitude less than 950 m or 3117 ft)	10 °C to 35 °C (50 °F to 95 °F) with no direct sunlight on the equipment.
Humidity Percentage Range	10% to 80% Relative Humidity with 26 °C (78.8 °F) maximum dew point.

Relative Humidity

Storage	5% to 95% RH with 33 °C (91 °F) maximum dew point. Atmosphere must be non-condensing at all times.
---------	--

Maximum Vibration

Operating	0.26 G _{rms} at 5 Hz to 350 Hz (all operation orientations).
Storage	1.87 G _{rms} at 10 Hz to 500 Hz for 15 min (all six sides tested).

Maximum Shock

Operating	One shock pulse in the positive z axis of 31 G for 2.6 ms in all operational orientations.
Storage	Six consecutively executed shock pulses in the positive and negative x, y, and z axes (one pulse on each side of the system) of 71 G for up to 2 ms.

Maximum Altitude

Operating	3048 m (10,000 ft).
Storage	12,000 m (39,370 ft).

Operating Altitude De-rating

Up to 35 °C (95 °F)	Maximum temperature is reduced by 1 °C/300 m (1 °F/547 ft) above 950 m (3,117 ft).
35 °C to 40 °C (95 °F to 104 °F)	Maximum temperature is reduced by 1 °C/175 m (1 °F/319 ft) above 950 m (3,117 ft).

Environmental

40 °C to 45 °C (104 °F to 113 °F)

Maximum temperature is reduced by 1 °C/125 m (1 °F/228 ft) above 950 m (3,117 ft).

Particulate Contamination

 **NOTE:** This section defines the limits to help avoid IT equipment damage and/or failure from particulates and gaseous contamination. If it is determined that levels of particulates or gaseous pollution are beyond the limits specified below and are the reason for the damage and/or failures to your equipment, it may be necessary for you to re-mediate the environmental conditions that are causing the damage and/or failures. Re-mediation of environmental conditions will be the responsibility of the customer.

Air Filtration

 **NOTE:** Applies to data center environments only. Air filtration requirements do not apply to IT equipment designed to be used outside a data center, in environments such as an office or factory floor.

Data center air filtration as defined by ISO Class 8 per ISO 14644-1 with a 95% upper confidence limit.

 **NOTE:** Air entering the data center must have MERV11 or MERV13 filtration.

Conductive Dust

 **NOTE:** Applies to data center and non-data center environments.

Air must be free of conductive dust, zinc whiskers, or other conductive particles.

Corrosive Dust

 **NOTE:** Applies to data center and non-data center environments.

- Air must be free of corrosive dust.
- Residual dust present in the air must have a deliquescent point less than 60% relative humidity.

Gaseous Contamination

 **NOTE:** Maximum corrosive contaminant levels measured at ≤50% relative humidity.

Copper Coupon Corrosion Rate

<300 Å/month per Class G1 as defined by ANSI/ISA71.04-1985.

Silver Coupon Corrosion Rate

<200 Å/month as defined by AHSRAE TC9.9.